



swisslicht

The ultimate searchlight

swisslicht SL1



sensationallight

Extraordinary features of the **swisslicht SL1**

Highest light output

One of the brightest, mobile lamps of the world (comparable with the light output of 6 medium class cars). 6 to 8 times better than standard halogen lamps.

Lowest energy consumption

A real energy saving lamp - with 40W it generates 4000 lumen. A normal light bulb will need at least 400W, a modern halogen lamp will need about 150W and LED will need 80 W to generate the same light output.

Longest range

Focused at about 3° one can see up to 1.5 km distance. The deployed mirror has been custom-designed for the mobile deployment of this type of HID-bulb.

Simple handling

With one single hand movement you can replace the rechargeable battery, no screwing, no cords, and no single use batteries. With a single hand movement you can change the focus of the beam and also change the light output between high output and long operation time.

Longest runtime for rechargeable batteries

One charge last more than 4 hours for long operation time (at ca. 2000

lumen) and more than 2 hours for high output (at ca. 3200 lumen). Charging time is less than 2 hours due to a new charging electronic. With a single spare rechargeable battery one can run the searchlight continuously - even in high output mode.

Compact electronic for ballast

The newly designed ballast-electronic is up to 10 times smaller than comparable solutions which offers big advantages in regard to design, weight and heat.

Perfect manufacturing and assembly

The manufactured aluminium body is so precisely worked and assembled that the searchlight is not only waterproof but also watertight until 30m (IP68). However, the swisslicht SL1 is not a diving lamp; neither bulb, mirror, contacts nor focusing mechanism are designed for underwater operations.

High end finish, custom design

All our products are distinguished by a high end finish which can be had in black anodised, coloured anodised, chrome, silver, and gold or many other finish and surface treatments. We offer also a custom design according to your requests.

Transport Box – Extra equipment



Mirror and Xenon HID Bulb



Lamp head and rechargeable battery separated



Filter and Filteradapter



Tripod Option



Easy use with a strap



Excellent light range of the **swisslicht SL1**

Target in 500 m distance

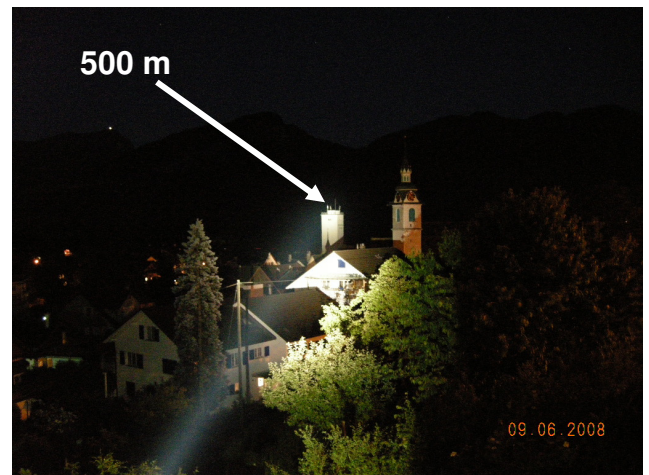

Target in 300 m distance

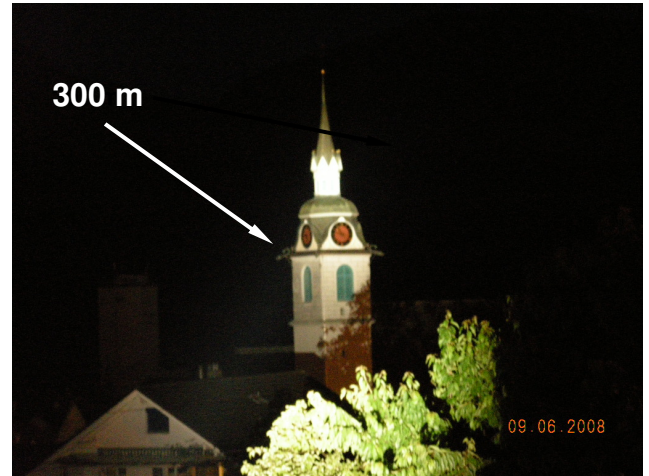
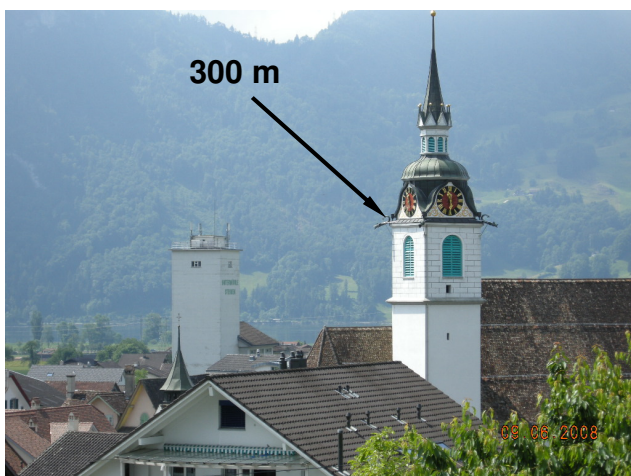

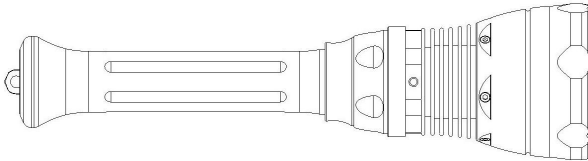

Searchlight:

Length:	485 mm
Diameter:	128 mm
Weight:	2650 g
Standard	IP 68 (30m)
Light:	HID Bulb
Consumption	35 Watt or 25 Watt
Colour Temperature	4100 K

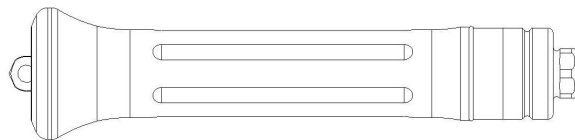

**Rechargeable
Li-Ion Battery:**

Length:	327 mm
Diameter:	50 mm
Weight:	1100 g
Charging Time 80%:	2:00 h
Charging Time 100%:	4:00 h
Working at 35 Watt:	2:30 h
Working at 25 Watt:	4:00 h
Loading Cycles:	>1000
Self discharge:	< 3% / Month

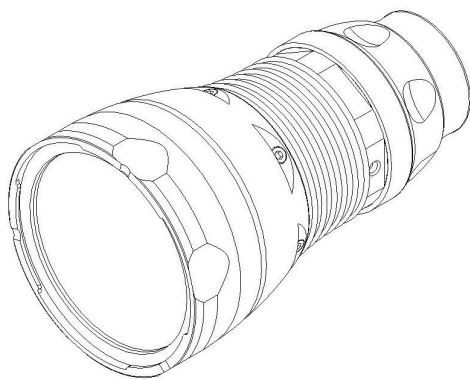

Lamp Head:

Length:	220 mm
Diameter:	140 mm
Weight:	1550 g
Front lens:	Borofloat, non-reflecting
Thickness:	3.8 mm
Mirror:	Aluminium metallised
Aperture:	105 mm
Filter socket:	Bayonet

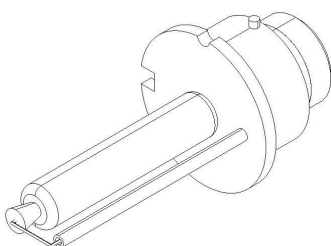

Light source:

Type	HID
35 Watt	3200 Lumen
25 Watt	1700 Lumen
After 1500 hours	75% or better
Light cone	spot and flood

About MULTIPLEX

Our main focus is to become a preferred supplier for our customers. We shall obtain this through

- **High quality products**
- **Accurate and timely information**
- **Short lead times**

We know how important “the right products to the right time” is to our customers, and as we believe that we shall aim towards mutual growth we have implemented tools to focus on precisely that.

In our battery division we have increased our flexibility by more staff in Denmark, as well as closer cooperation with our suppliers Sanyo, Panasonic, FDK, HYB, Varta and others. Through this enhanced cooperation we can supply cells and battery packs for all types of applications.

In our power division we have a very strong mix of DC/DC products from the two manufacturers: Brandner and Alfatronix providing a broad platform for DC-conversion in both industrial and mobile application. Along with Clayton Power and Mastercom products we offer a complete range of products to the mobile requirement for power supply.

We look forward to service you.